

**System: Laufschiene eingetutet oder aufgeschraubt, keine Nut im Boden, ohne Blende, Clip-Laufwerk mit Finger-Justierrad, für 2 Holztüren bis 16 kg. Design Inslide**

System: Running track groove or surface mounted, no groove in the floor, without panel, clip-on running gear with thumbwheel adjuster, for 2 wooden doors up to 16 kg. Design Inslide

Système: Rail de roulement rainuré ou vissé en applique, aucune rainure dans le sol, sans cache, chariot de roulement à clipser avec molette de réglage, pour 2 portes en bois jusqu'à 16 kg max. Design Inslide

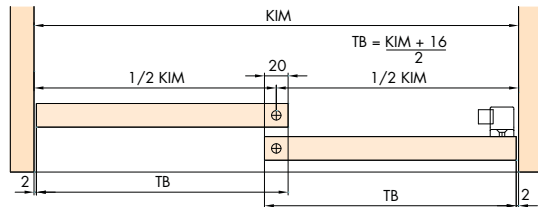
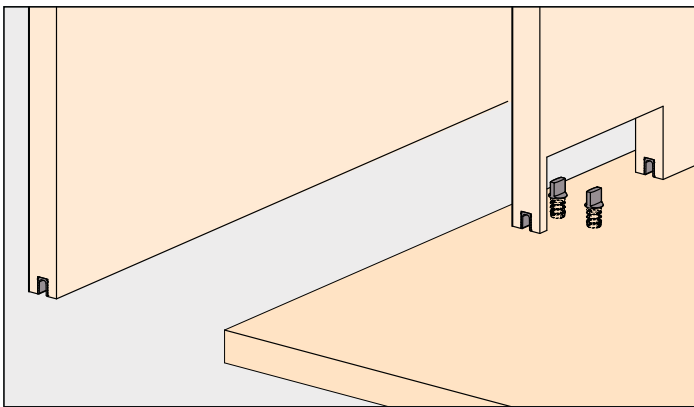

**Einbaubeispiele/Mounting examples/Exemples de montage**

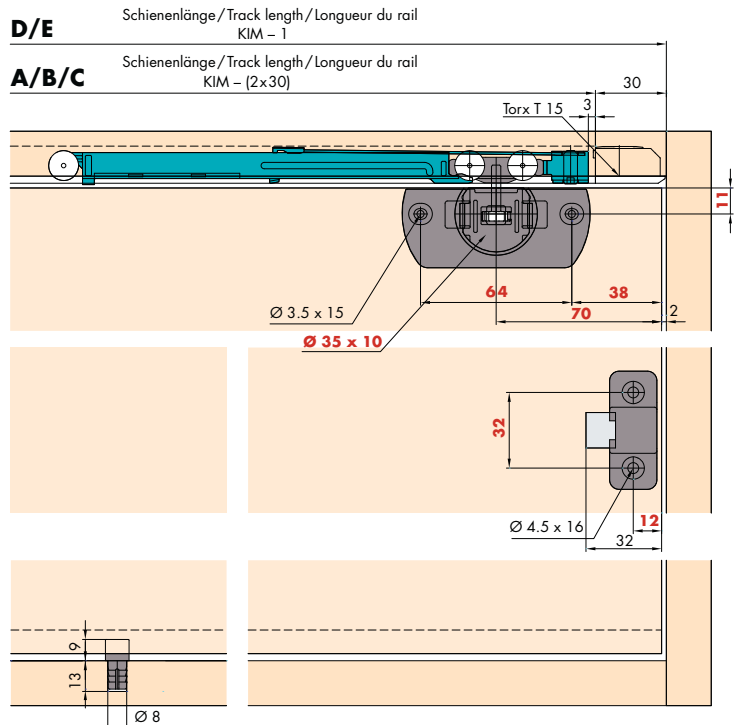
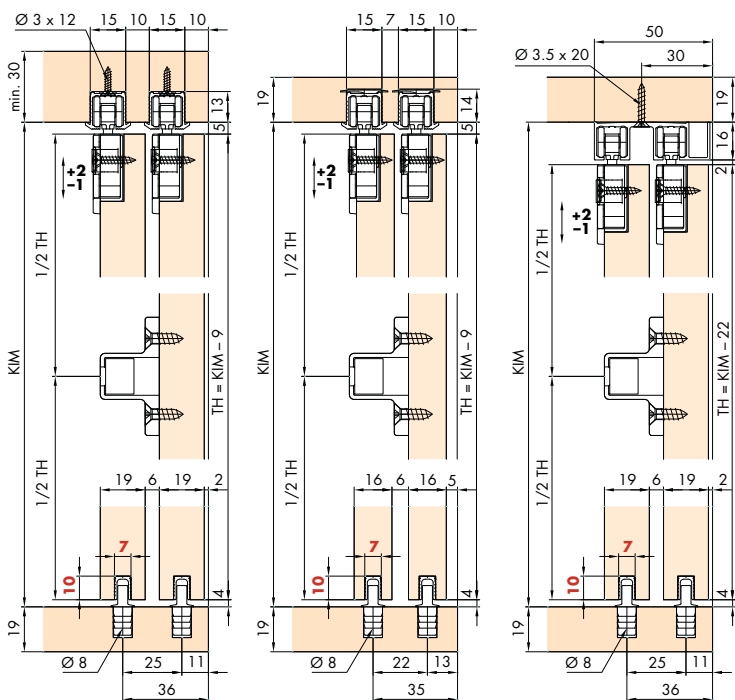

**Türbearbeitung = rote Zahlen/Door treatment = red numbers/Traitement de portes = numéros en rouge**  
**Dämpfung optional/Soft close optional/Amortissement en option** 66/67

**Befestigungsvarianten/Mounting options/Variantes de fixation**

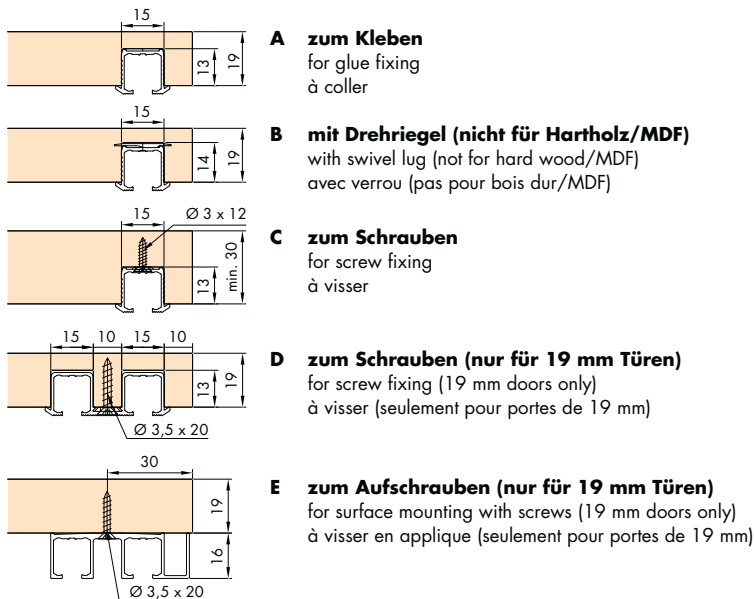

**Türgewichte**  
Door weights  
Poids de portes **75**

**Garnituren / Sets / Garnitures**

<b>2</b> Türen Doors Portes		<b>No. 053.3220.071</b>	
	4x		2x
	4x		2x
	1x		

**Zubehör/Accessories/Accessoires**

**A Einfachlaufschiene Alu, zum Kleben**

Single running track aluminium, for glue fixing  
Rail de roulement simple en alu, à coller

Gr./Size	Art. No.
2500 mm	053.3229.250
3500 mm	053.3229.350
6000 mm	053.3229.600

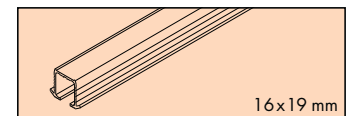

**B Einfachlaufschiene Alu, mit Drehriegel (nicht für Hartholz/MDF)**

Single running track aluminium, with swivel lug (not for hard wood/MDF)  
Rail de roulement simple en alu, avec verrou (pas pour bois dur/MDF)

Gr./Size	Art. No.
2500 mm	053.3227.250
3500 mm	053.3227.350
6000 mm	053.3227.600

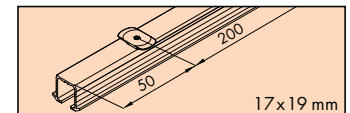

**C Einfachlaufschiene Alu, gelocht, zum Schrauben**

Single running track aluminium, pre-drilled, for screw fixing  
Rail de roulement simple en alu, perforé, à visser

Gr./Size	Art. No.
2500 mm	053.3225.250
3500 mm	053.3225.350
6000 mm	053.3225.600

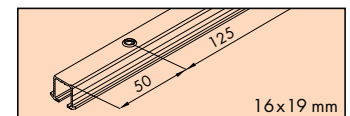

**Schienenendstück, Kunststoff grau, mit Drehriegel (nicht für Hartholz/MDF)**

Track end piece, plastic grey, with swivel lug (not for hard wood/MDF)  
Pièce d'extrémité, plastique gris, avec verrou (pas pour bois dur/MDF)

Gr./Size	Art. No.
2x	053.3211.081

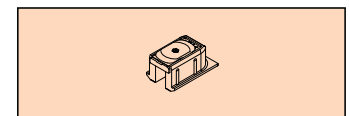

**Schienenendstück, Kunststoff grau, zum Schrauben**

Track end piece, plastic grey, for screw fixing  
Pièce d'extrémité, plastique gris, à visser

Gr./Size	Art. No.
2x	053.3210.081

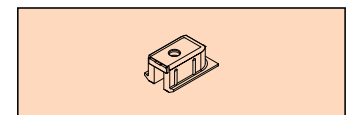

**D Doppellaufschiene Alu, gelocht, zum Schrauben**

Double running track aluminium, pre-drilled, for screw fixing  
Rail de roulement double en alu, perforé, à visser

Gr./Size	Art. No.
2500 mm	053.3226.250
3500 mm	053.3226.350
6000 mm	053.3226.600

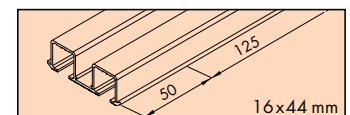

**E Doppellaufschiene, Alu eloxiert, gelocht, zum Aufschauben**

Double running track, aluminium anodized, pre-drilled, surface mounted  
Rail de roulement double en alu, anodisé, perforé, à visser en applique

Gr./Size	Art. No.
2500 mm	053.3231.250
3500 mm	053.3231.350
6000 mm	053.3231.600

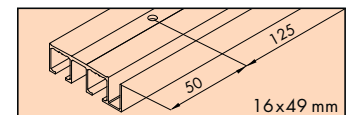

**Führungsschiene, Kunststoff anthrazit, 7 mm**

Guide track, plastic anthracite, 7 mm  
Rail de guidage, en plastique anthracite, 7 mm

Gr./Size	Art. No.
2500 mm	053.3012.250
3500 mm	053.3012.350
6000 mm	053.3012.600

